

NNR13S

360°发光悬绷霓虹 NEW

10M超长安装 纤细紧致不松垮

什么是刚性悬绷霓虹？

NNR13S

VS

传统霓虹

✔ 钢丝承受重量，灯体不松垮

✘ 硅胶承受重量，灯体易变形

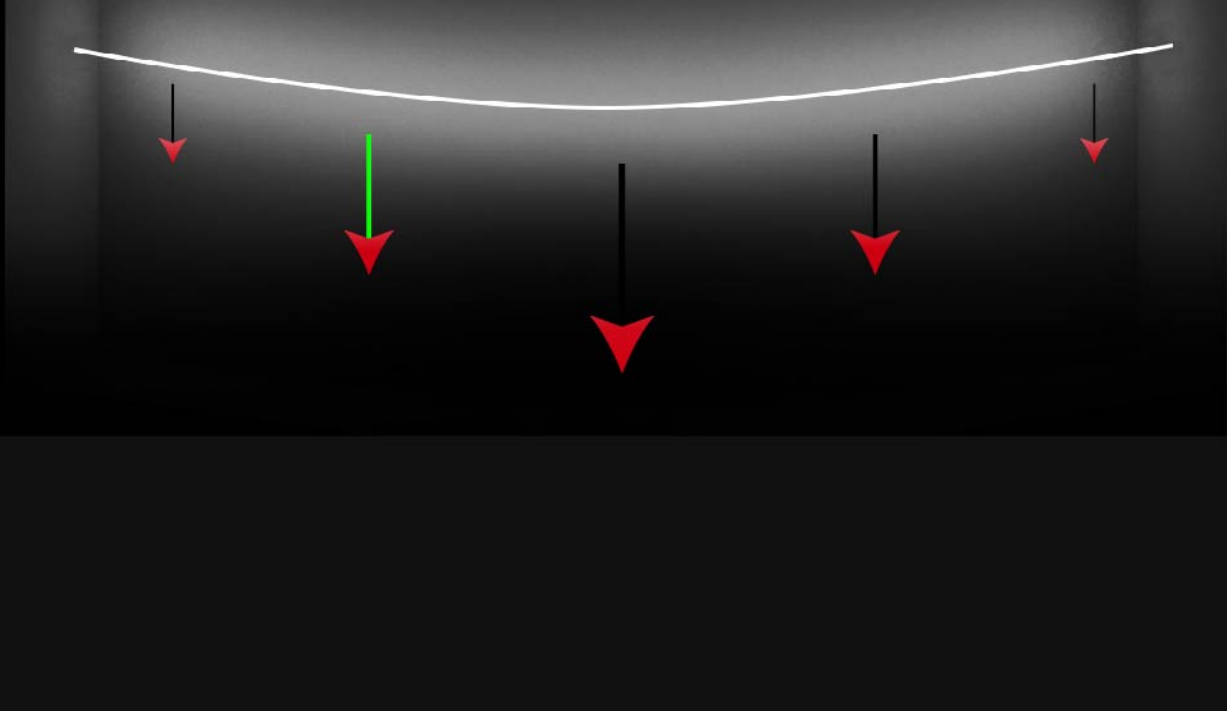
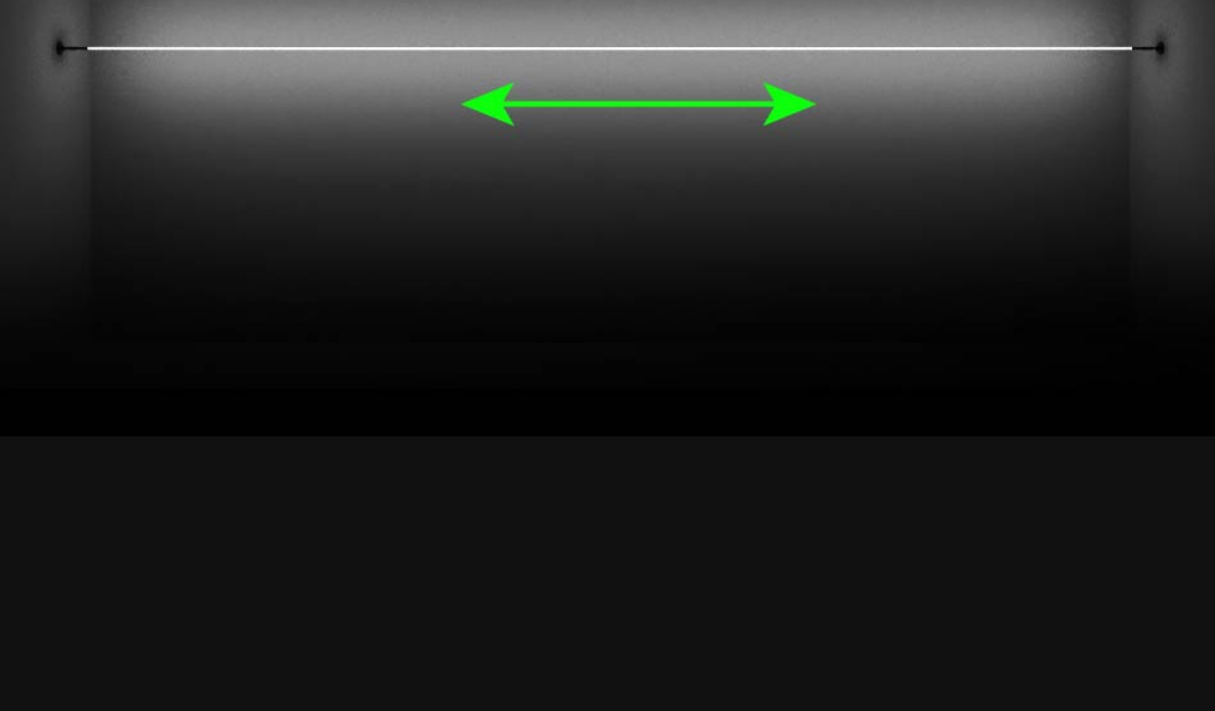

NNR13S为什么可受力悬绷？

内含钢丝，一体化成型

NNR13S

VS

传统霓虹



NNR13S

长距离 大跨度
造型持久

整圆发光

360°霓虹硅胶灯带

基础组件结构

内部结构



旋转组装

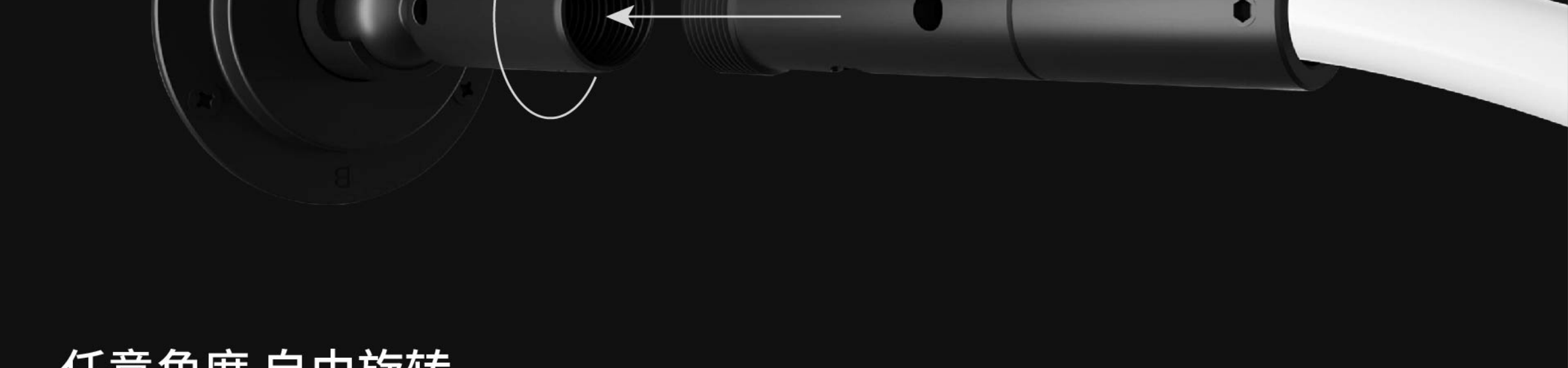

任意角度 自由旋转

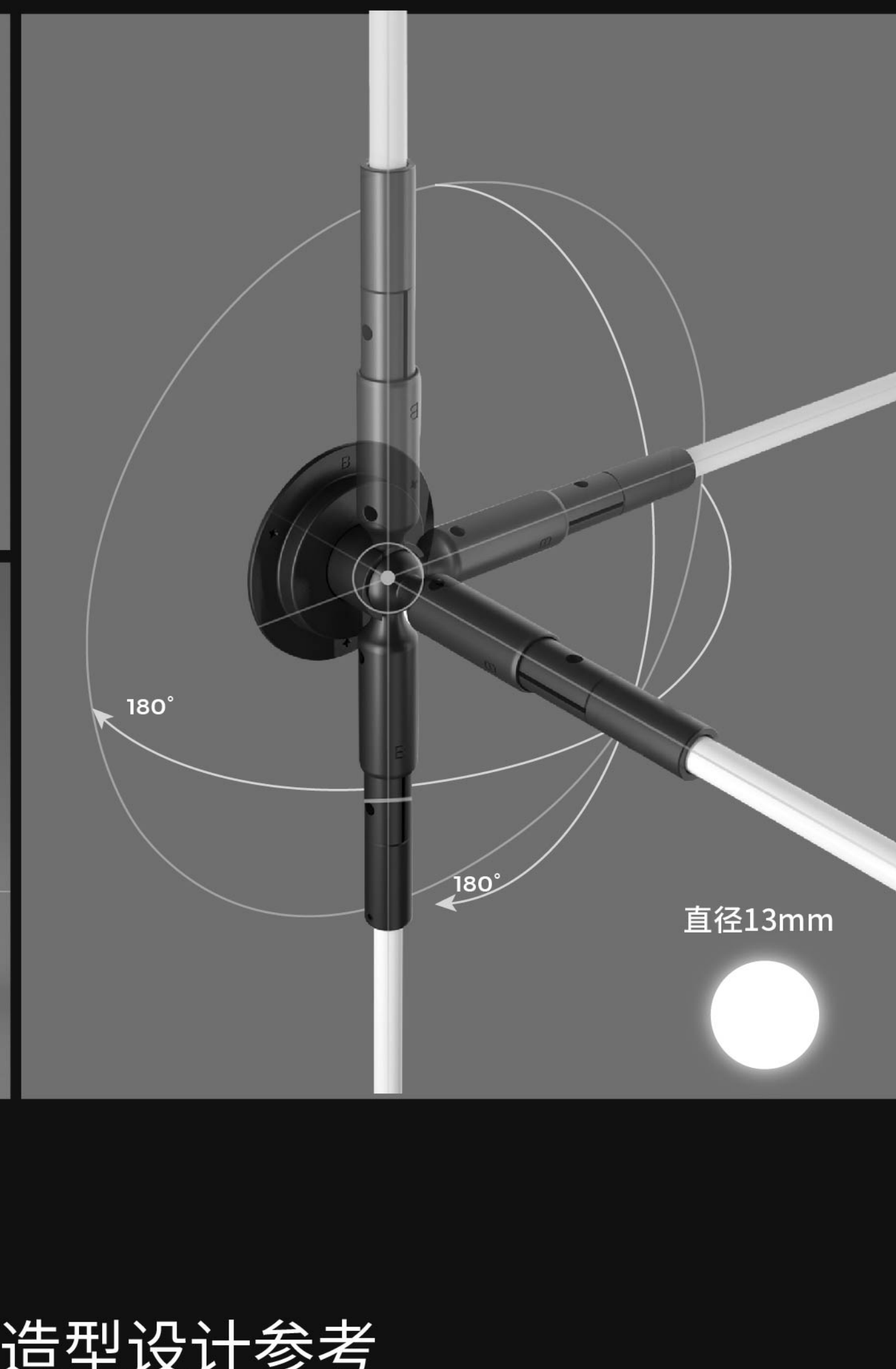
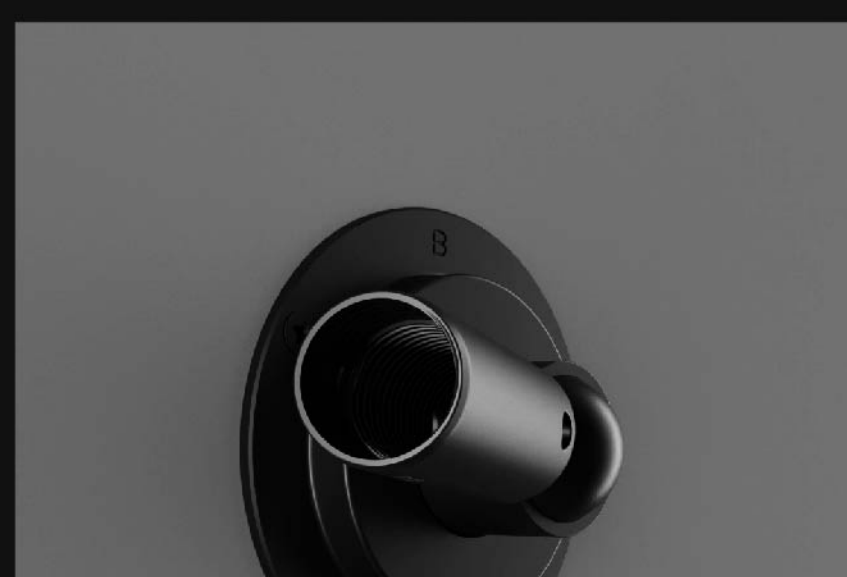

造型设计参考

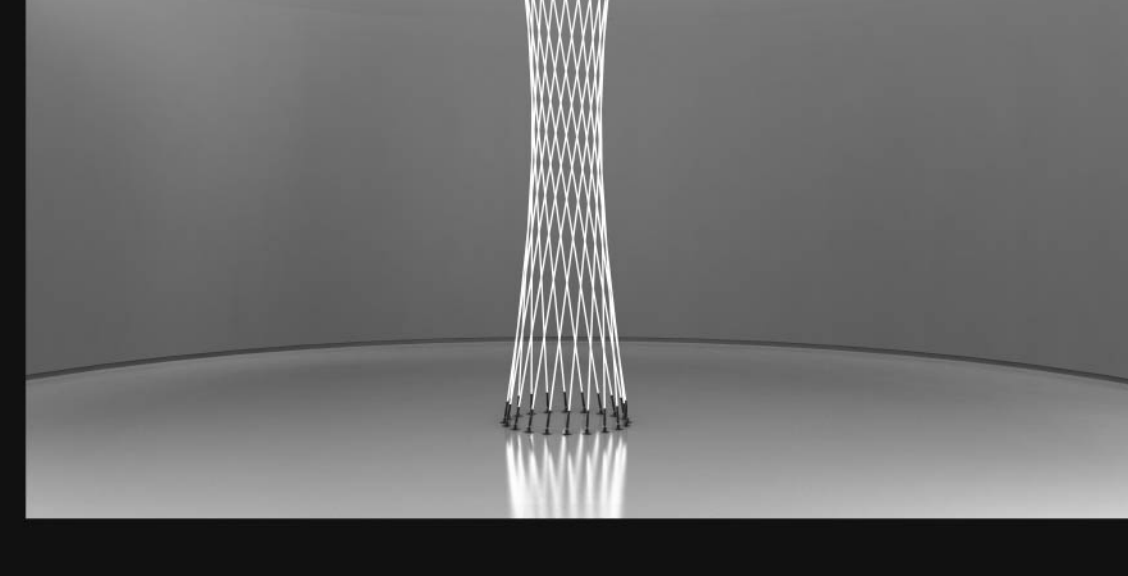
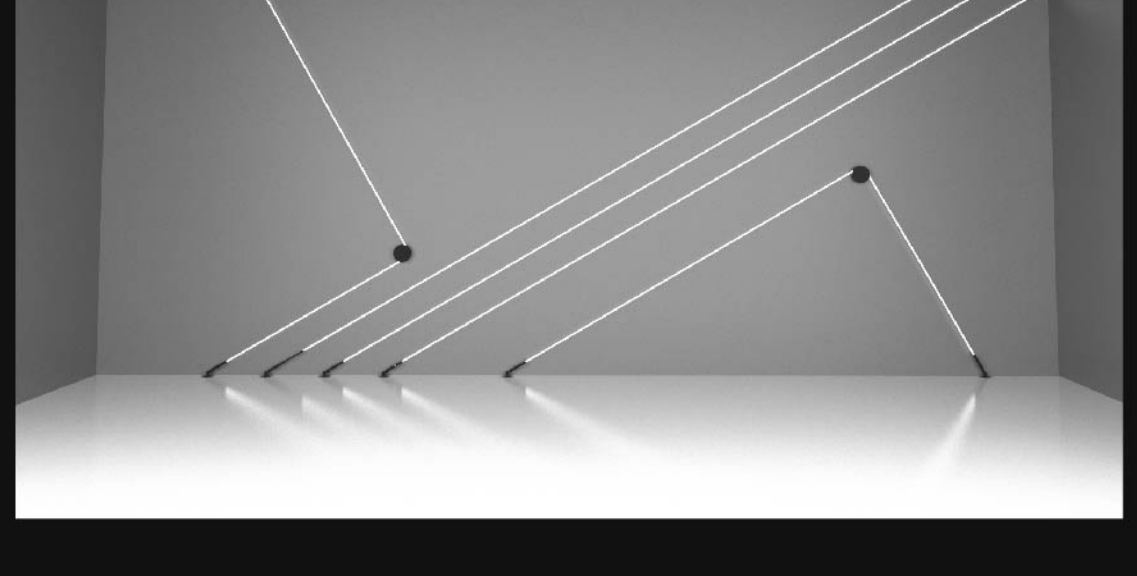
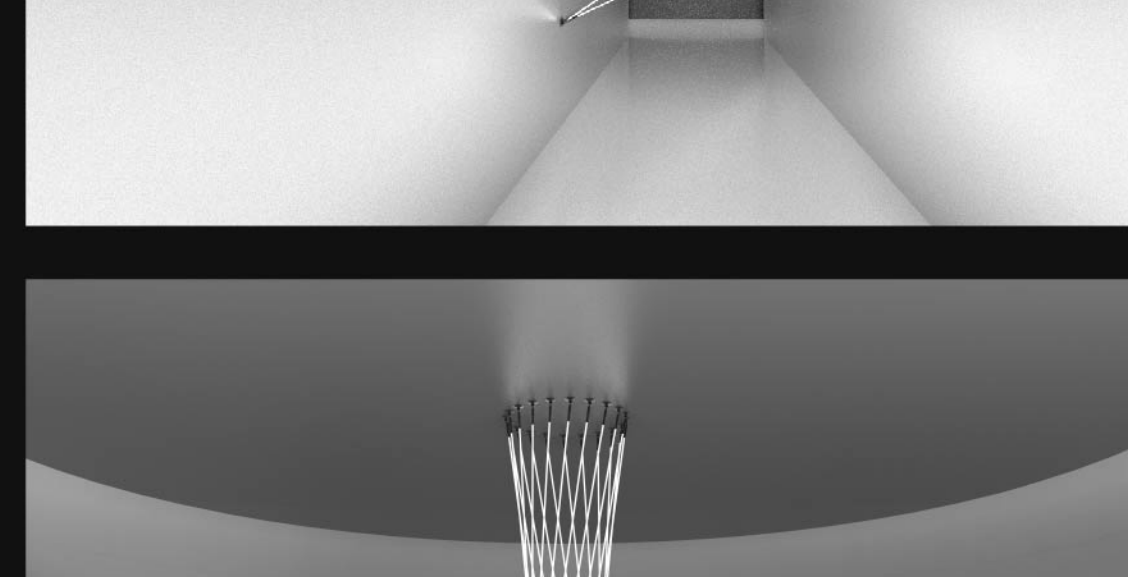
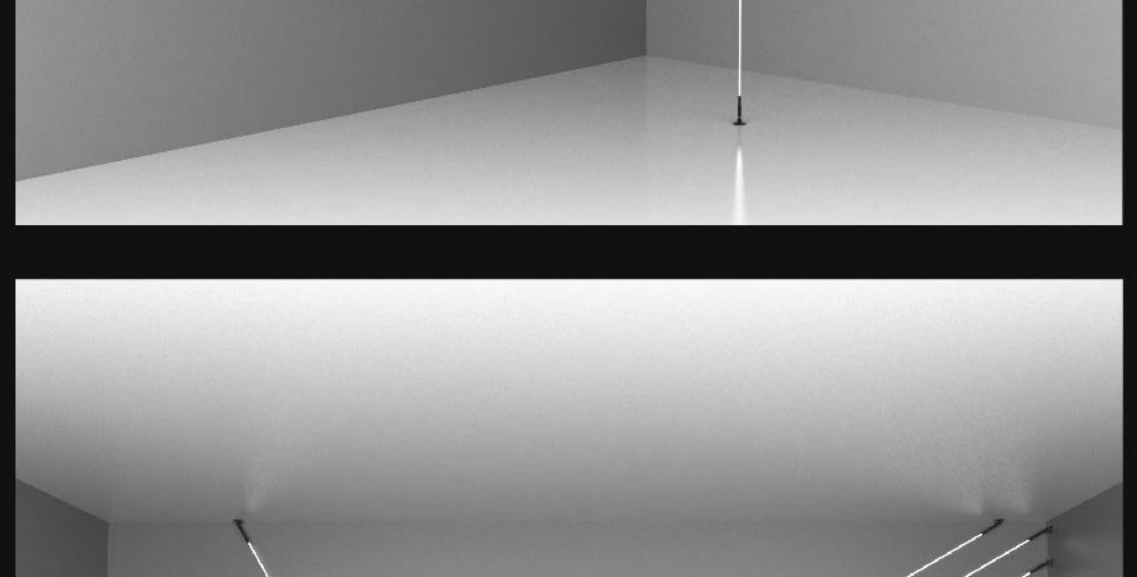

应用案例



产品参数

| 型号 | 尺寸 | 最小截型(eds/mm) | 输入电压 | 最大功率(w) | 色温 | 典型功率(w) | 光通量(lm/m) | 显指 | 防护等级 |
|--------|-----------|--------------|------|---------|-------|---------|-----------------|-----|------|
| NNR13S | 5000/Φ13 | 14LED/25mm | 24 | 9.6 | 3000K | 8.6 | 395/435/465/480 | >90 | IP65 |
| NNR13S | 10000/Φ13 | 28LED/50mm | 48 | 9.6 | 3000K | 8.6 | 395/435/465/500 | >90 | IP65 |